

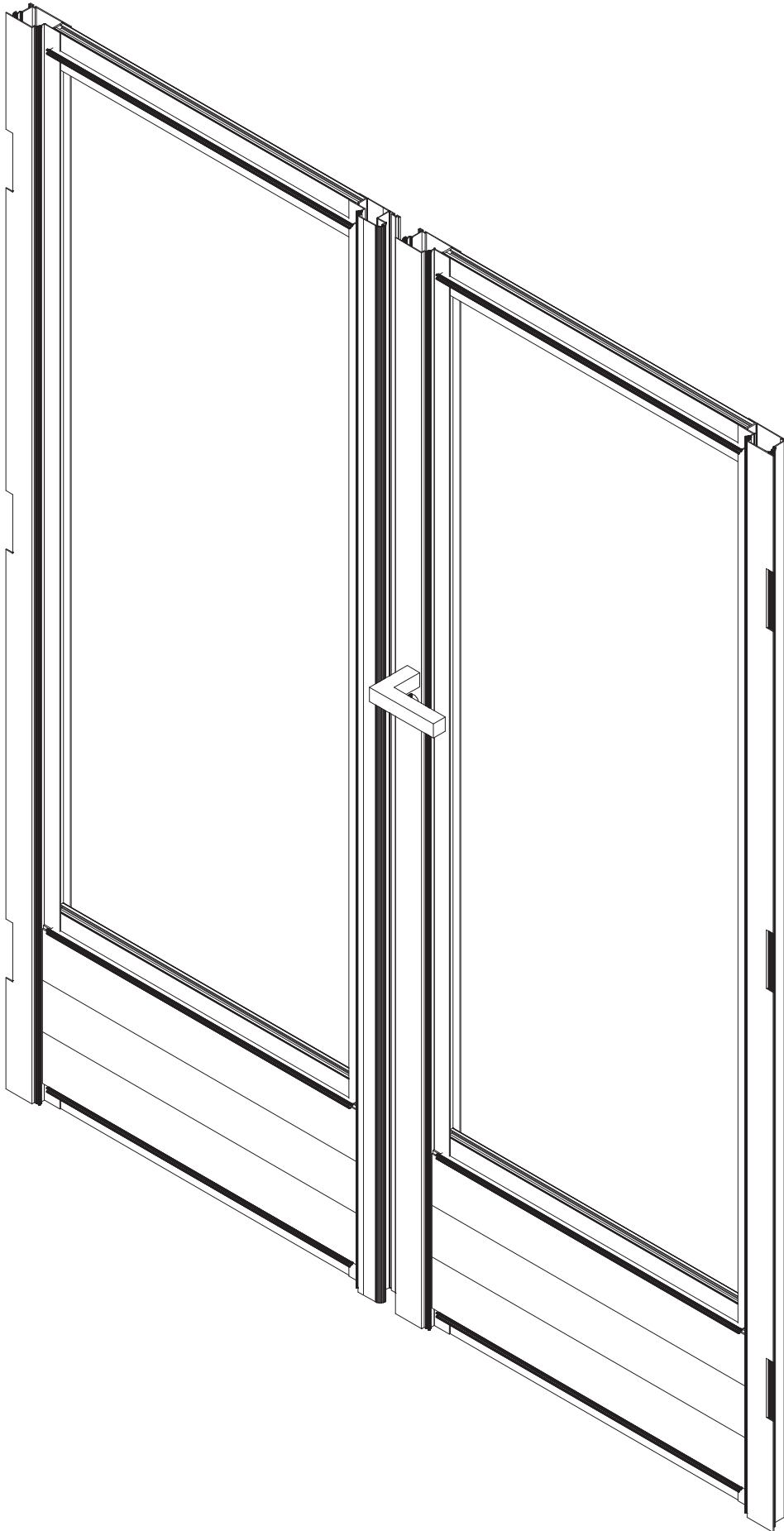









Double turning door

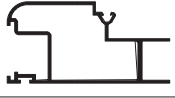
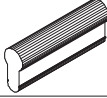
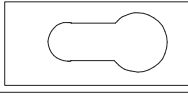
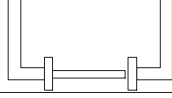

Profile list Double Turning Door

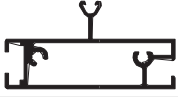
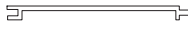
ES. Nr.	Prof. Nr.	Description	Drawing	Pieces
37		Black cap		24 x
		Screw cilinder M5 x 40		1 x
129		Parker screw ø 4,8 x 19 mm		24 x
		Doorprofile with lock		1 x
	37342	Doorprofile		2 x
	12962	Doorprofile		1 x
		Cilinder for lock		1 x
		Black plate for cilinder		2 x
		Doorhandles		1 x
		Screw M4,2 x 25		6 x
	9916	Middle door		6 x
	11969	fill panel		
		Screw Plates		12 x
115		Bolt M6 x 10 A2 sunk Head		24 x
		Hinges		6 x

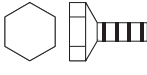
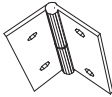
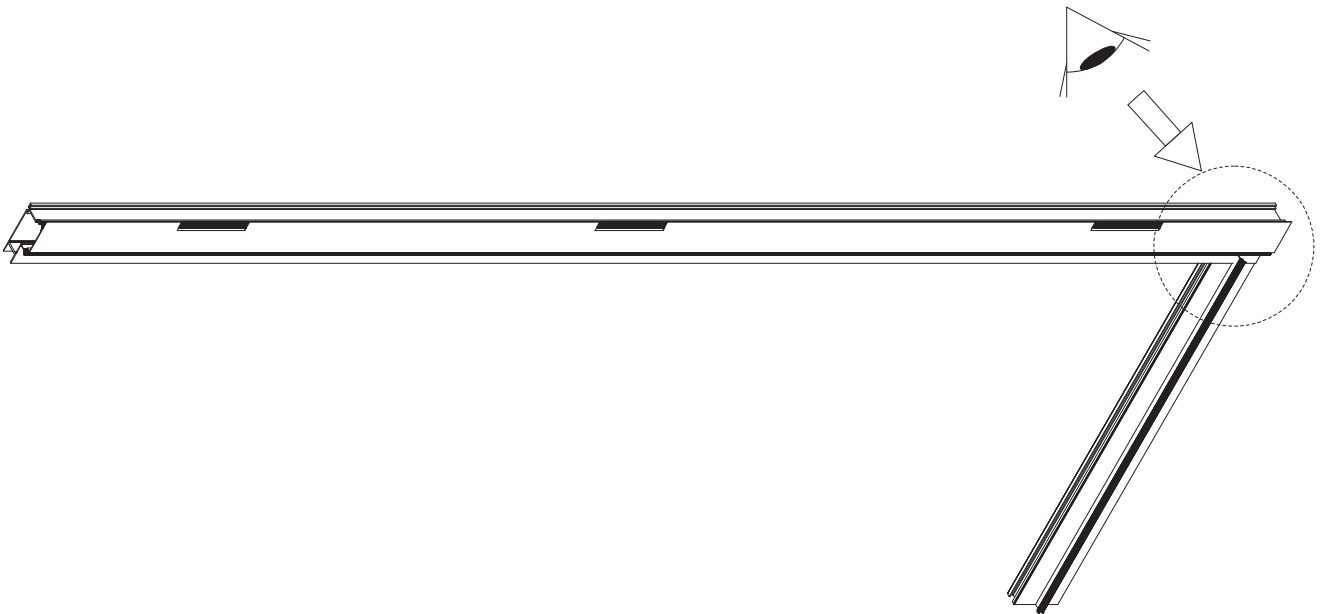
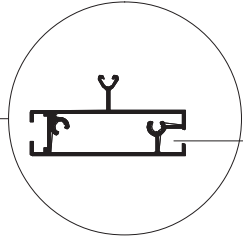
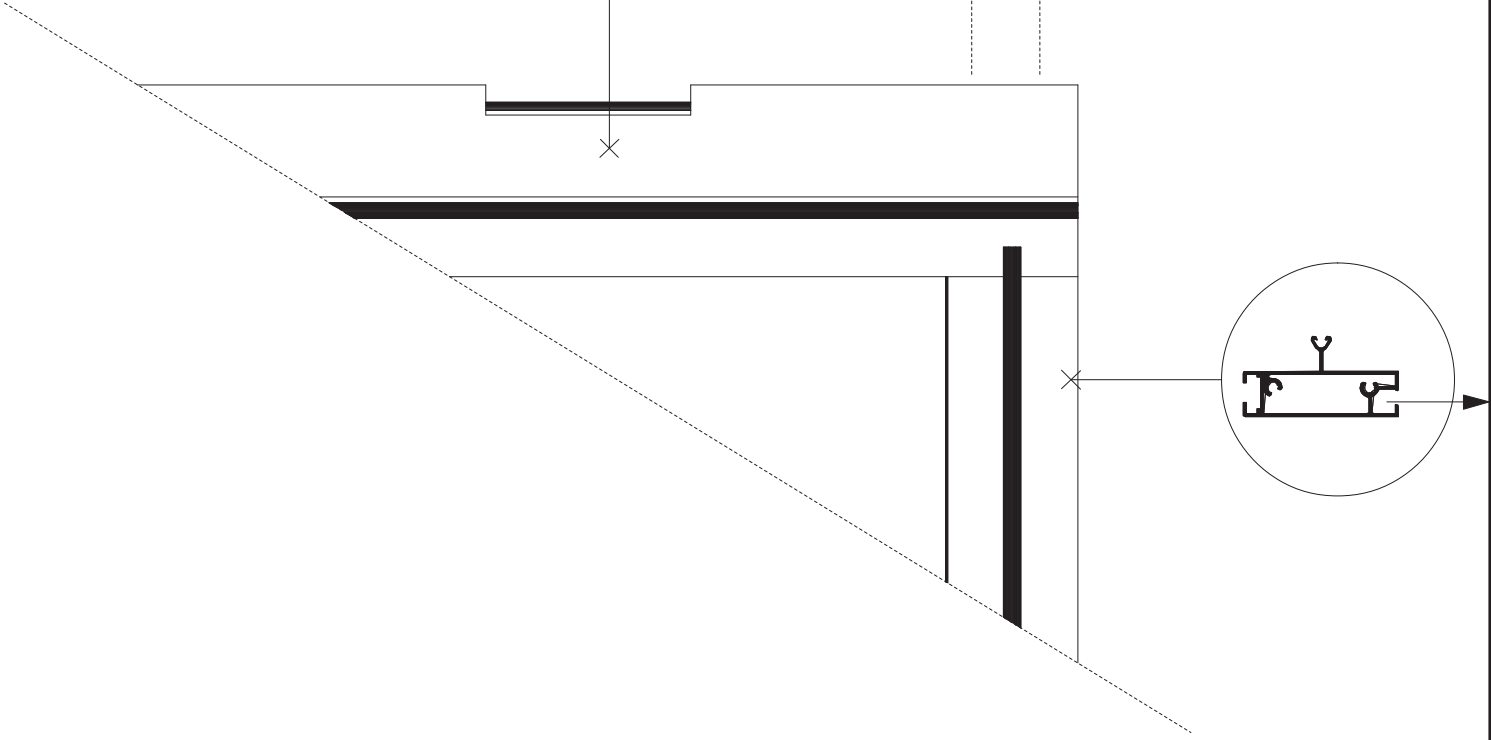
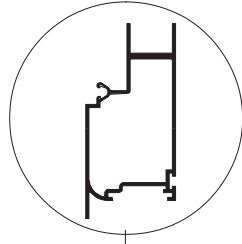
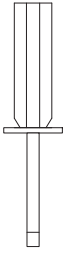

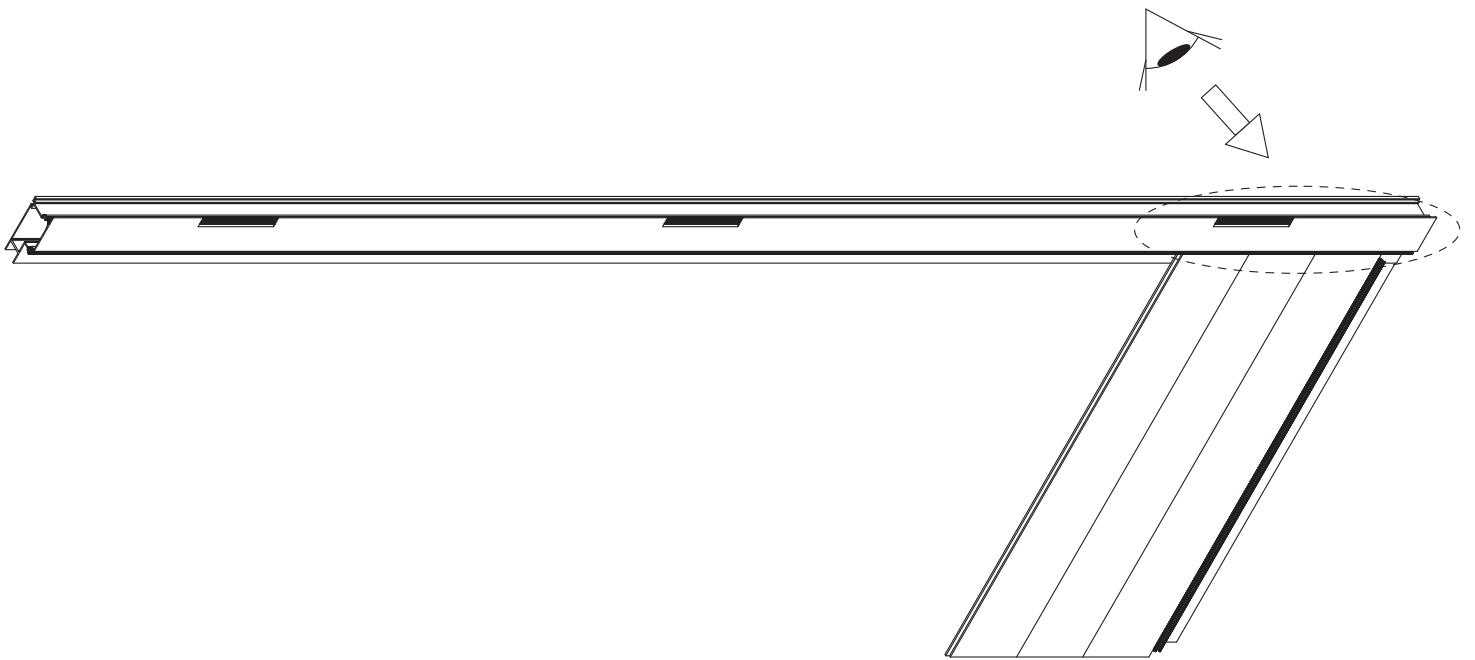

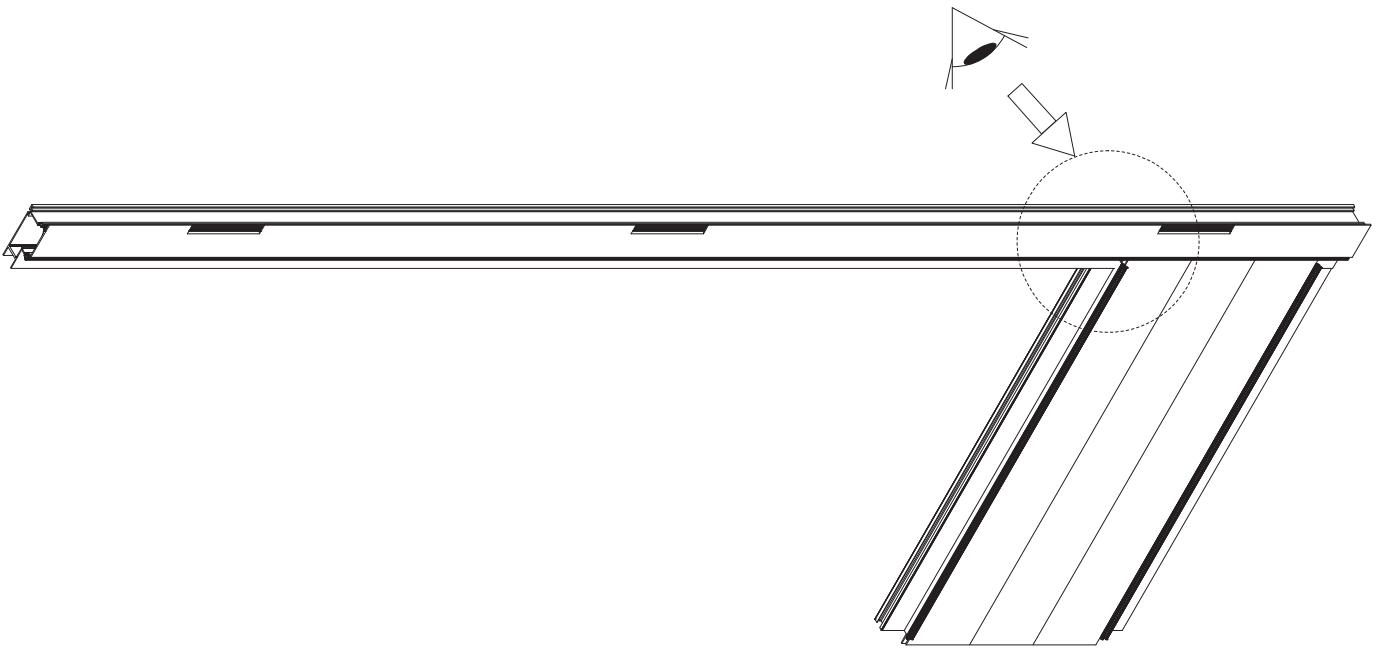
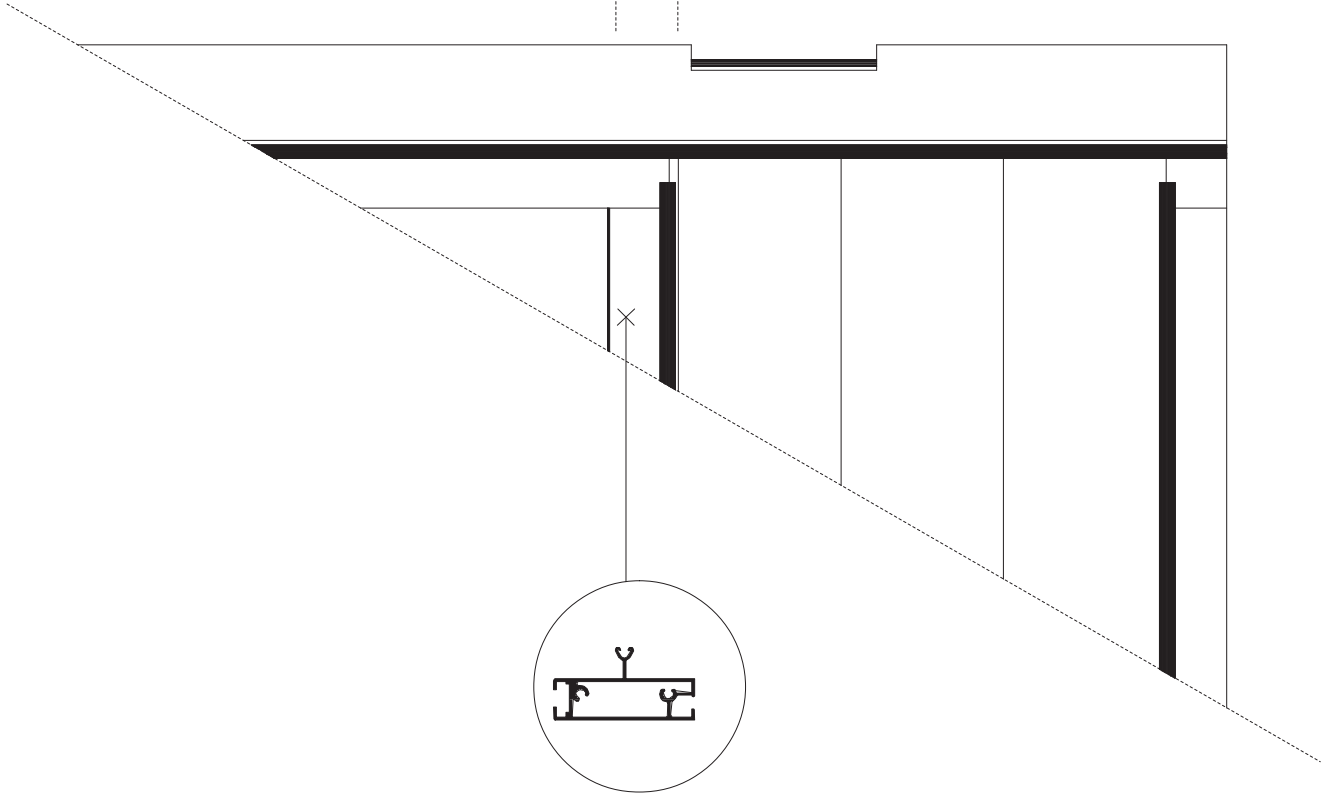
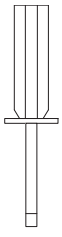

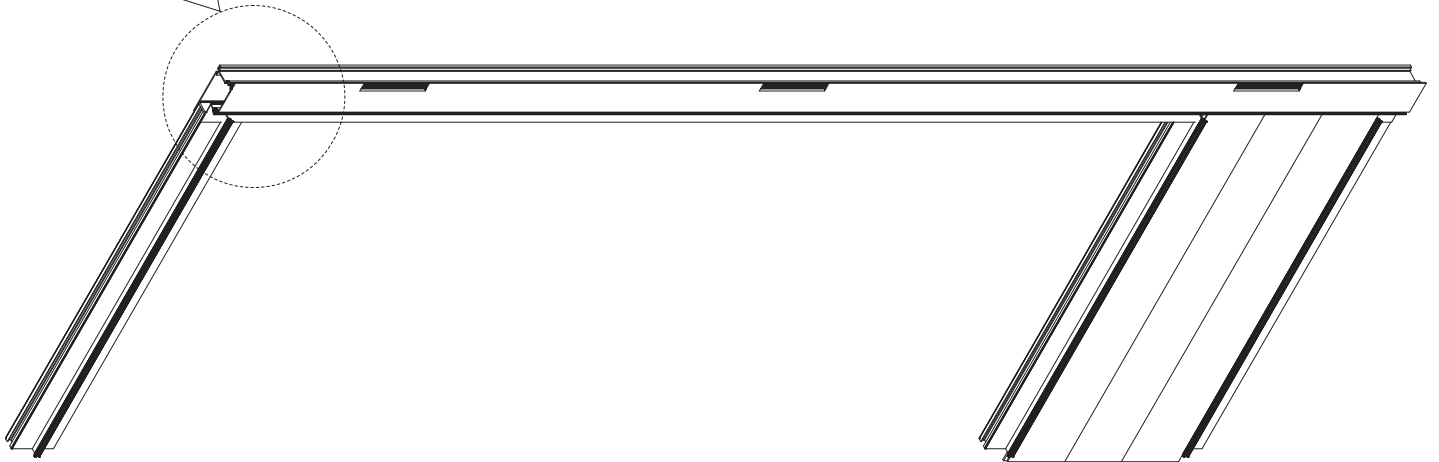
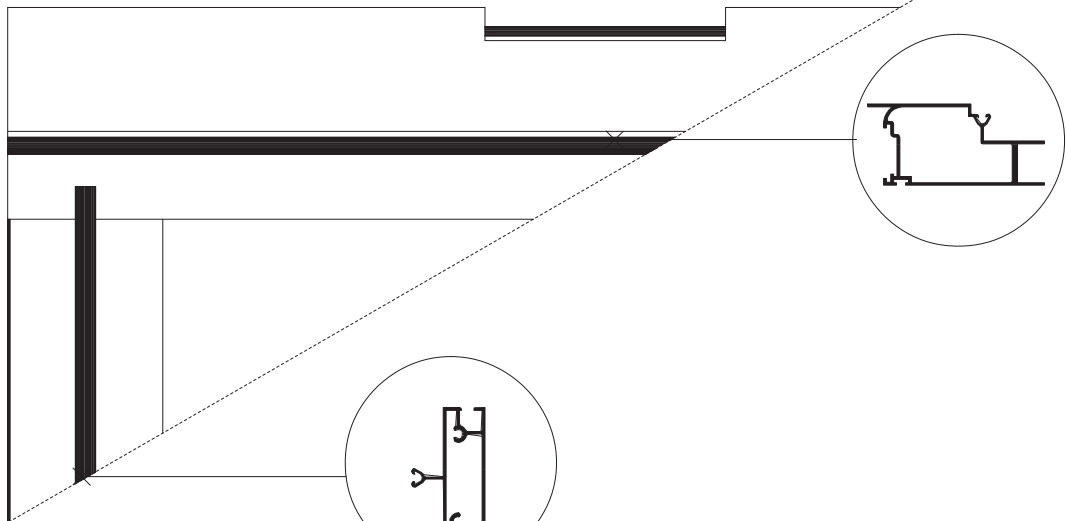
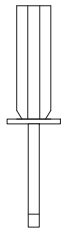

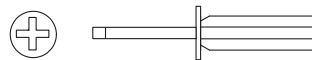
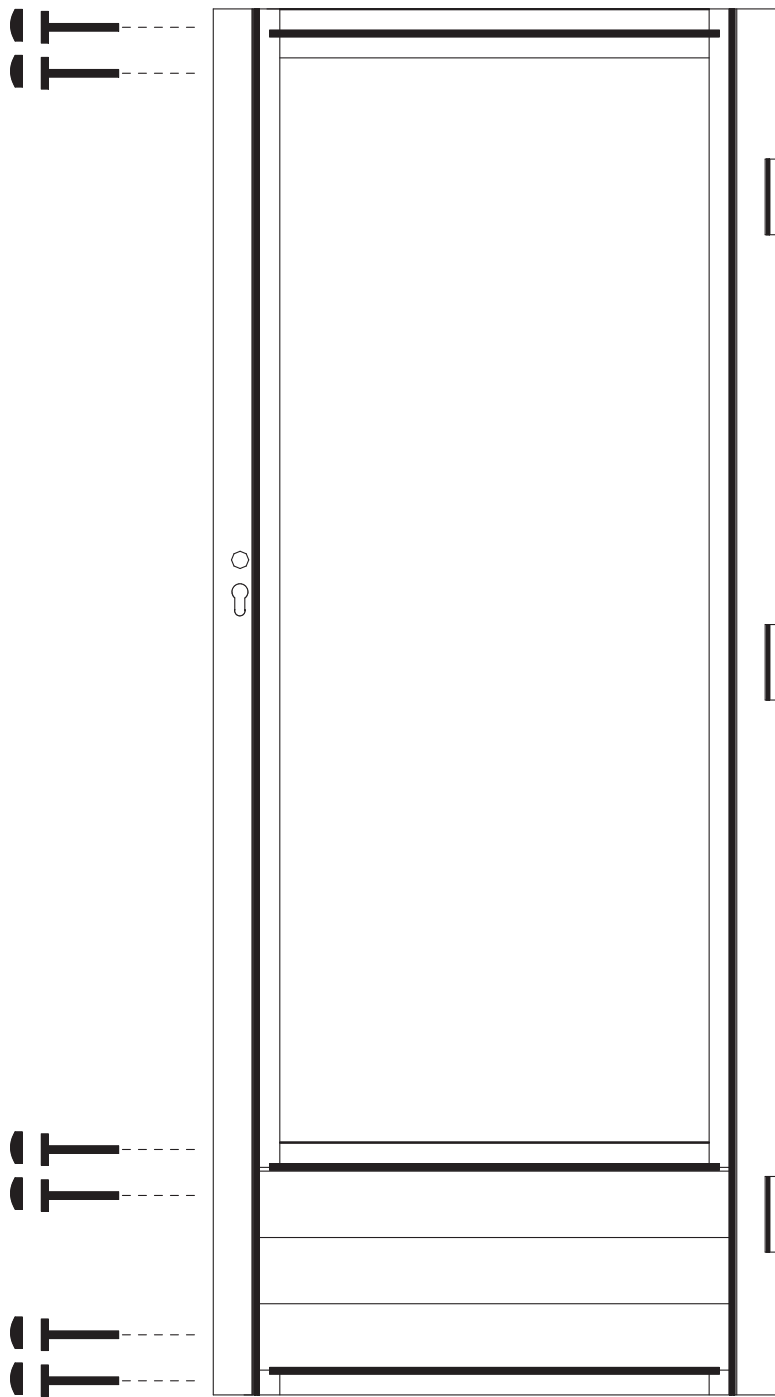

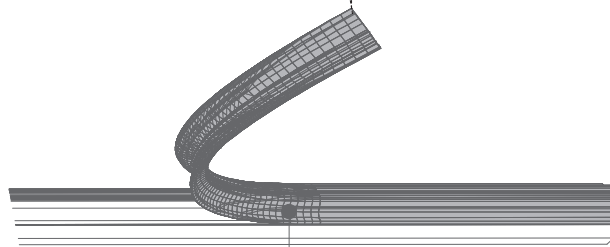
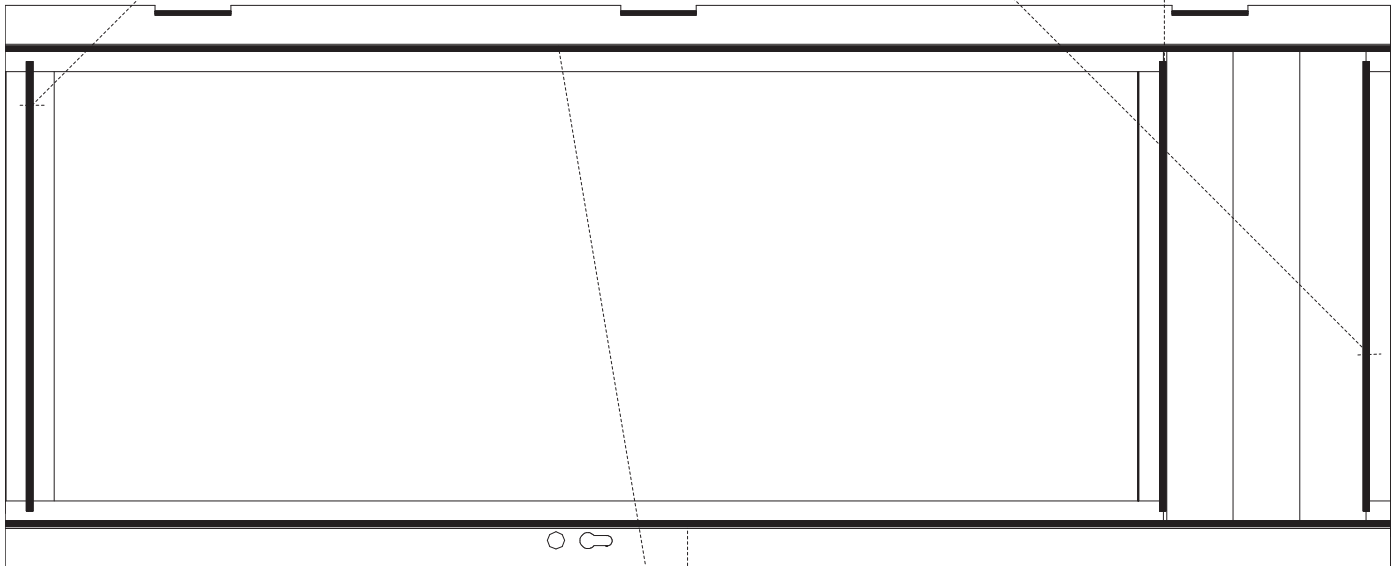
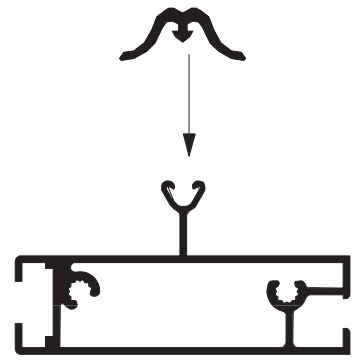
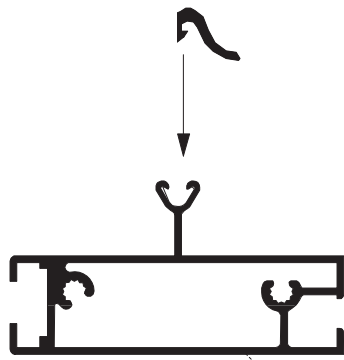

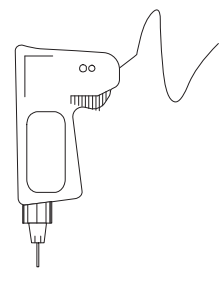
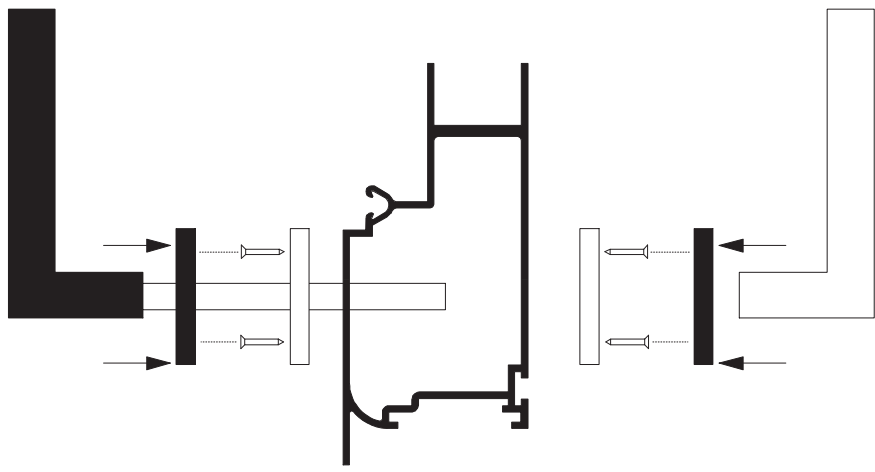
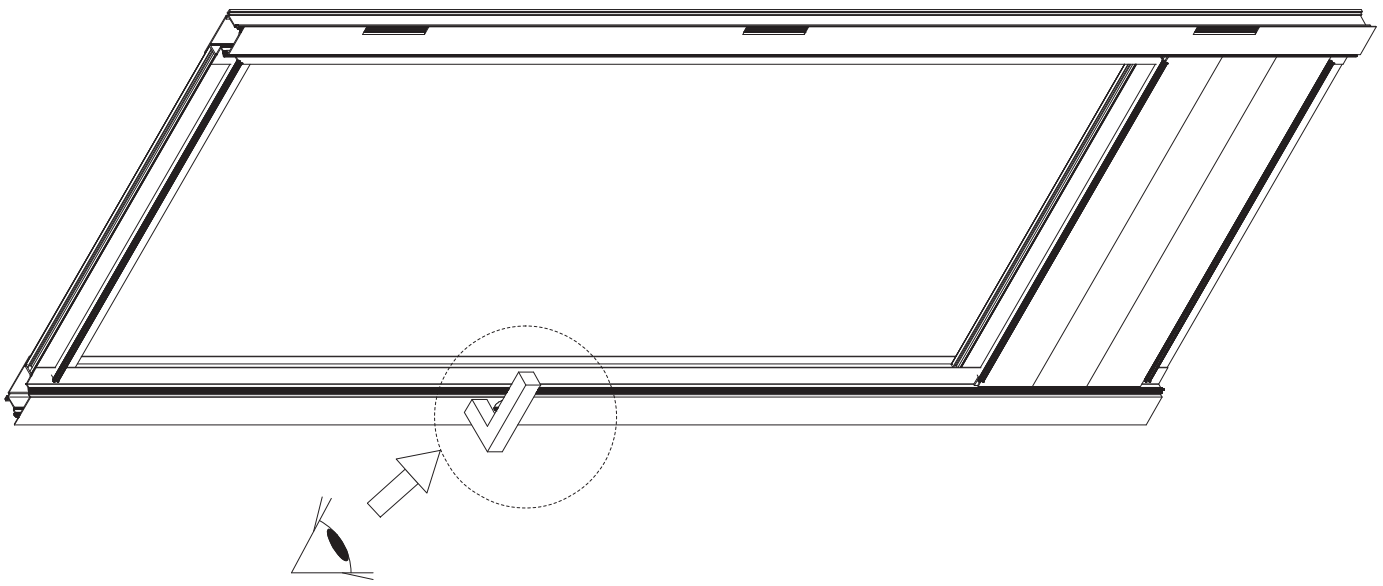

Ø 3,5 mm

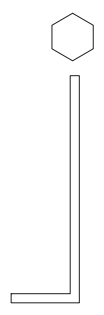

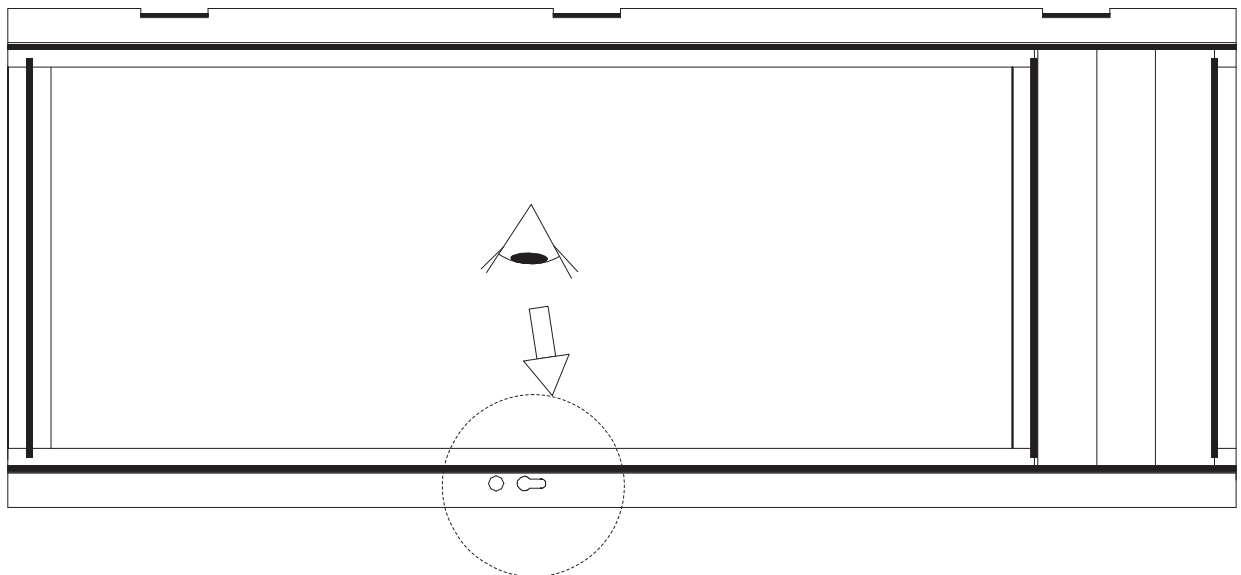
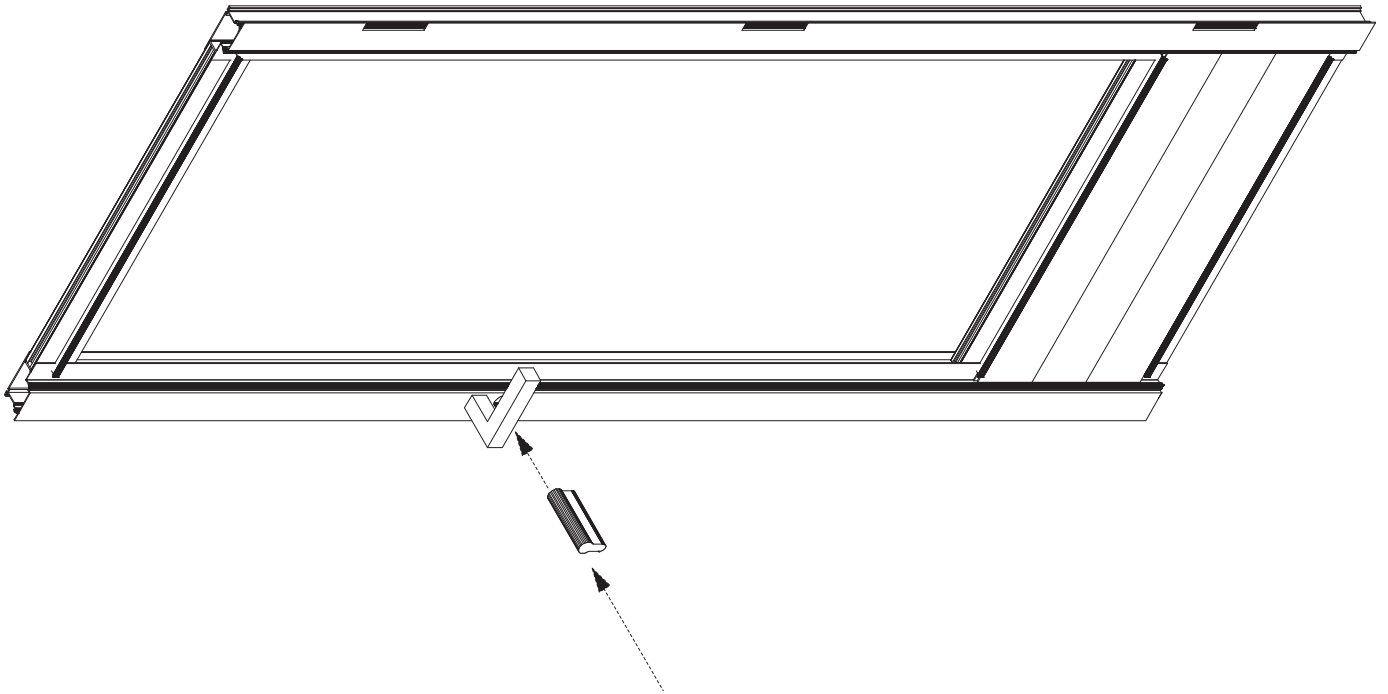
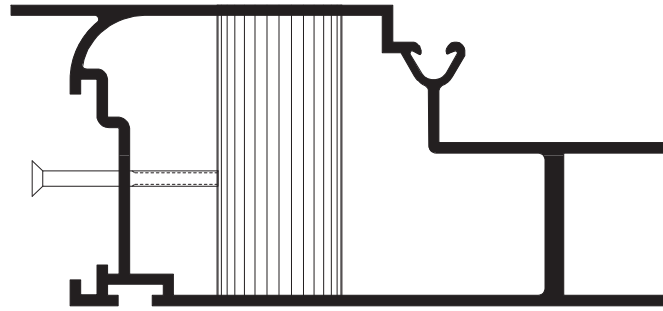
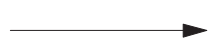
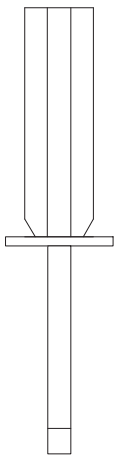

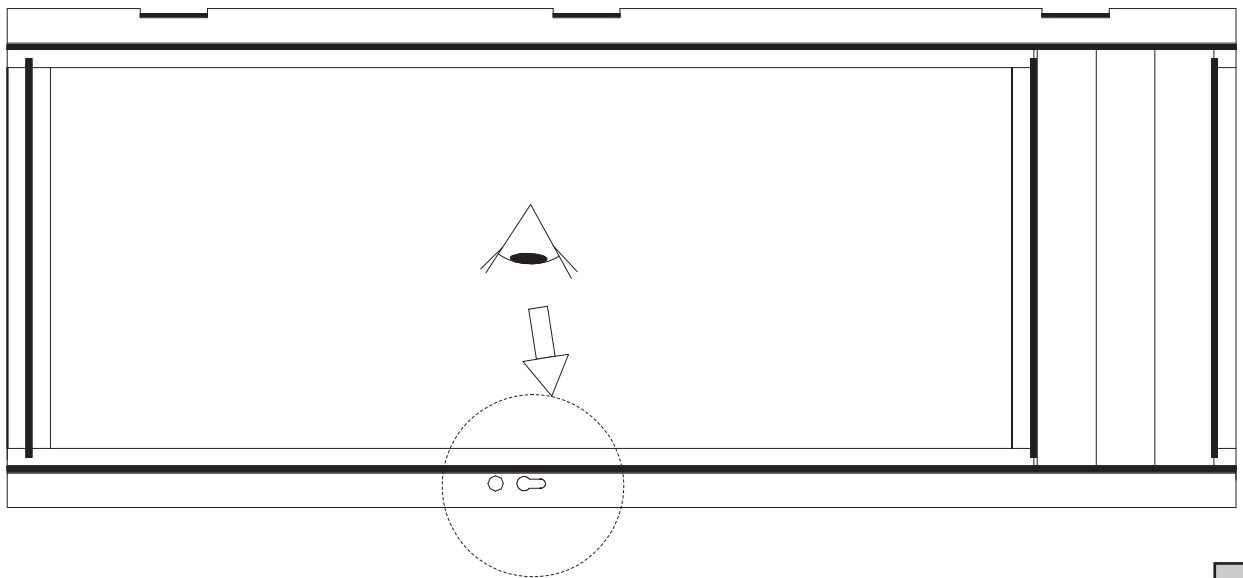
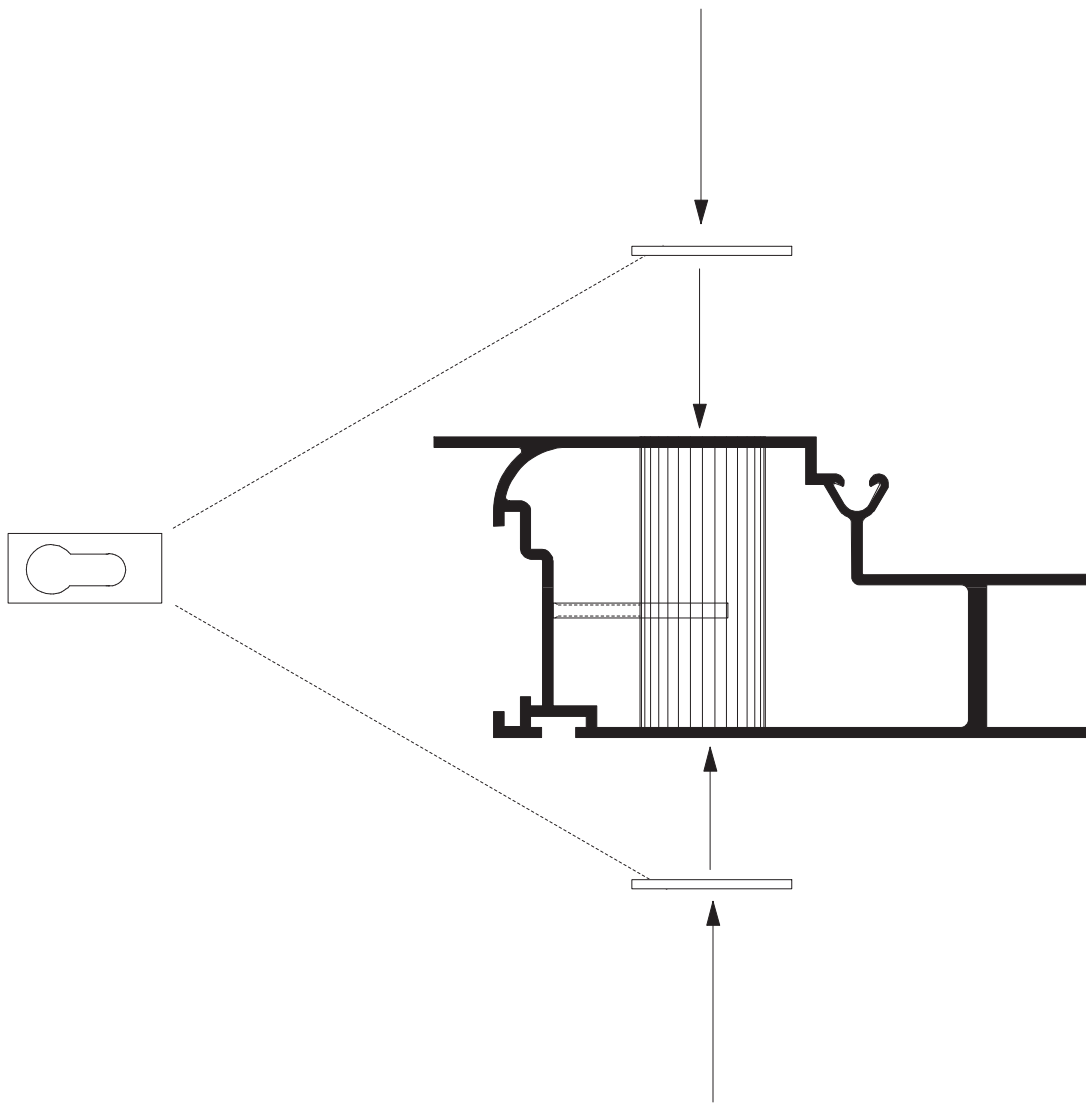

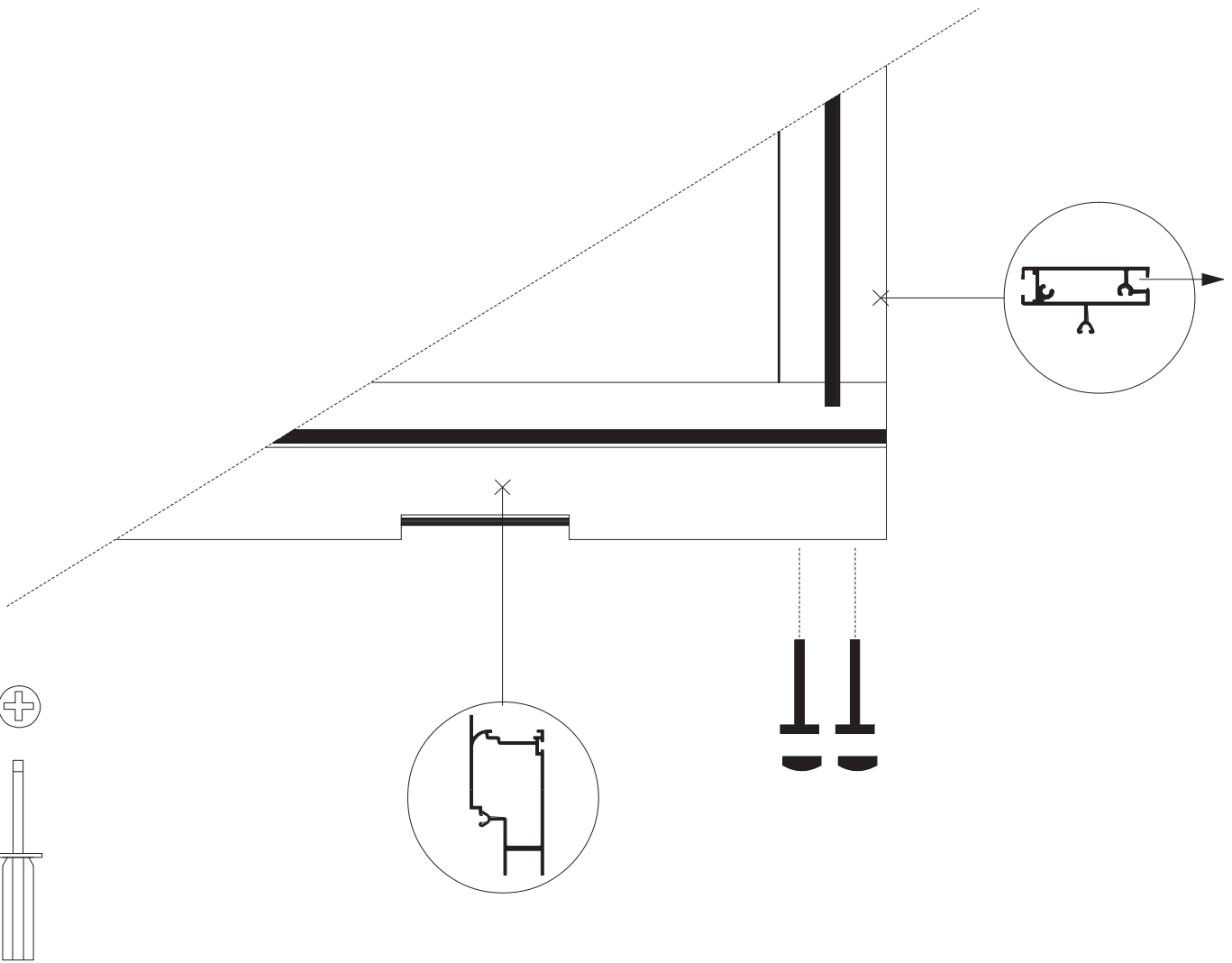
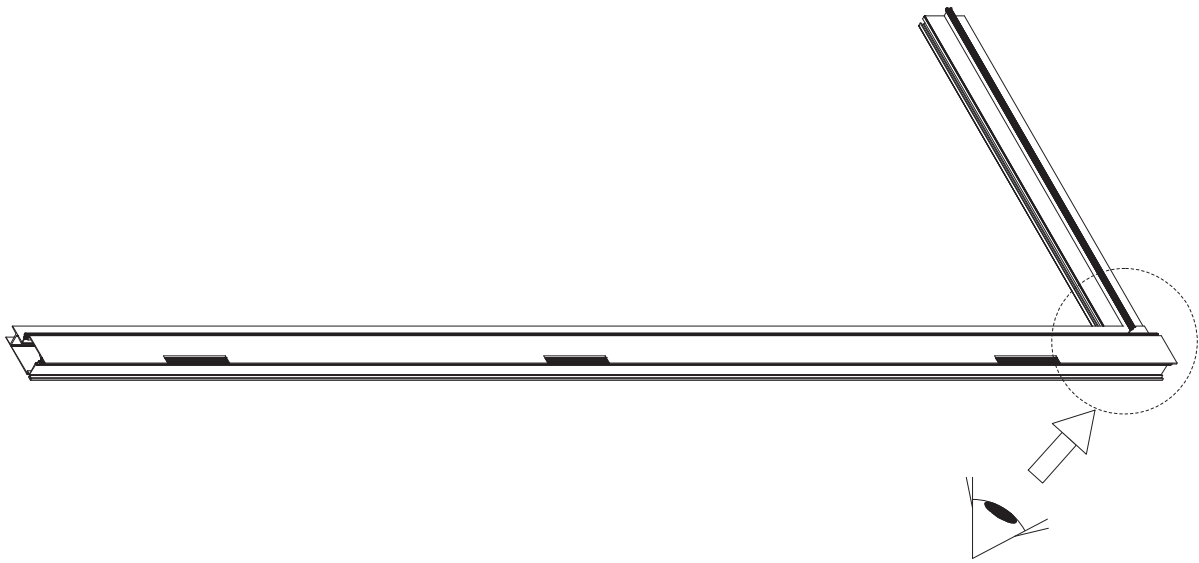

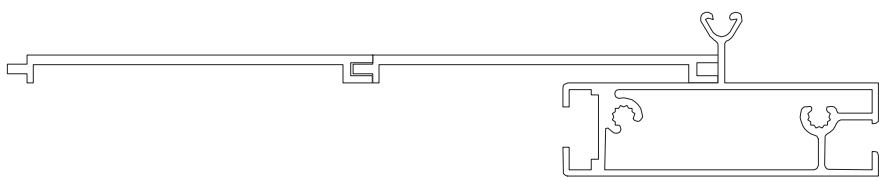
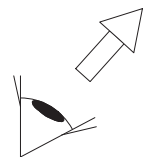
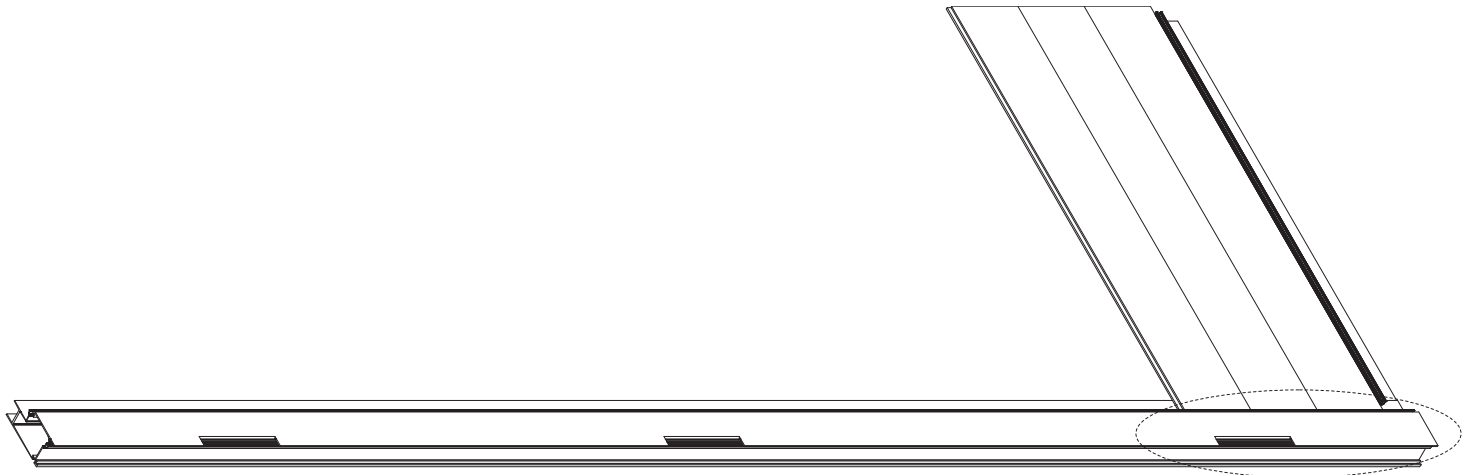

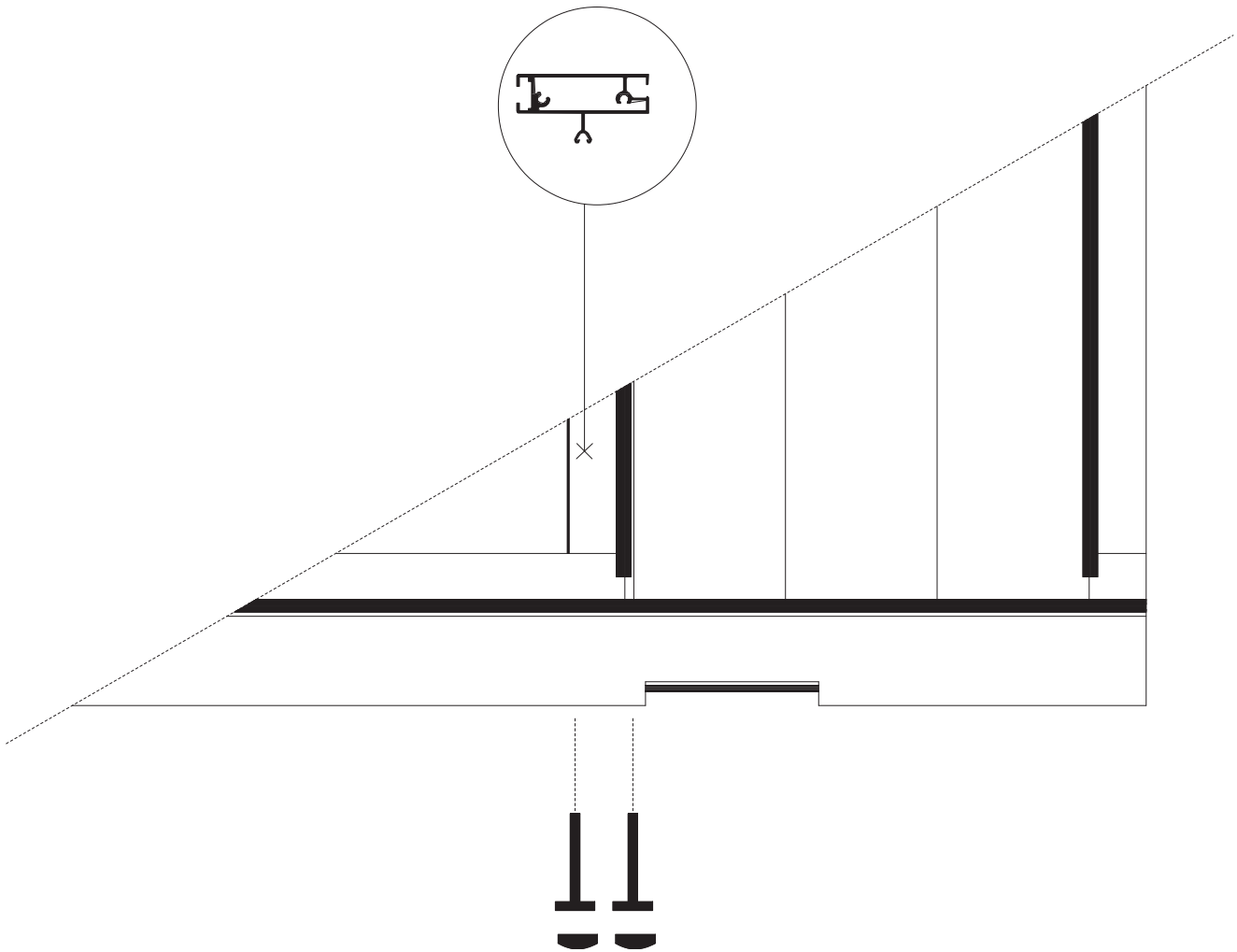
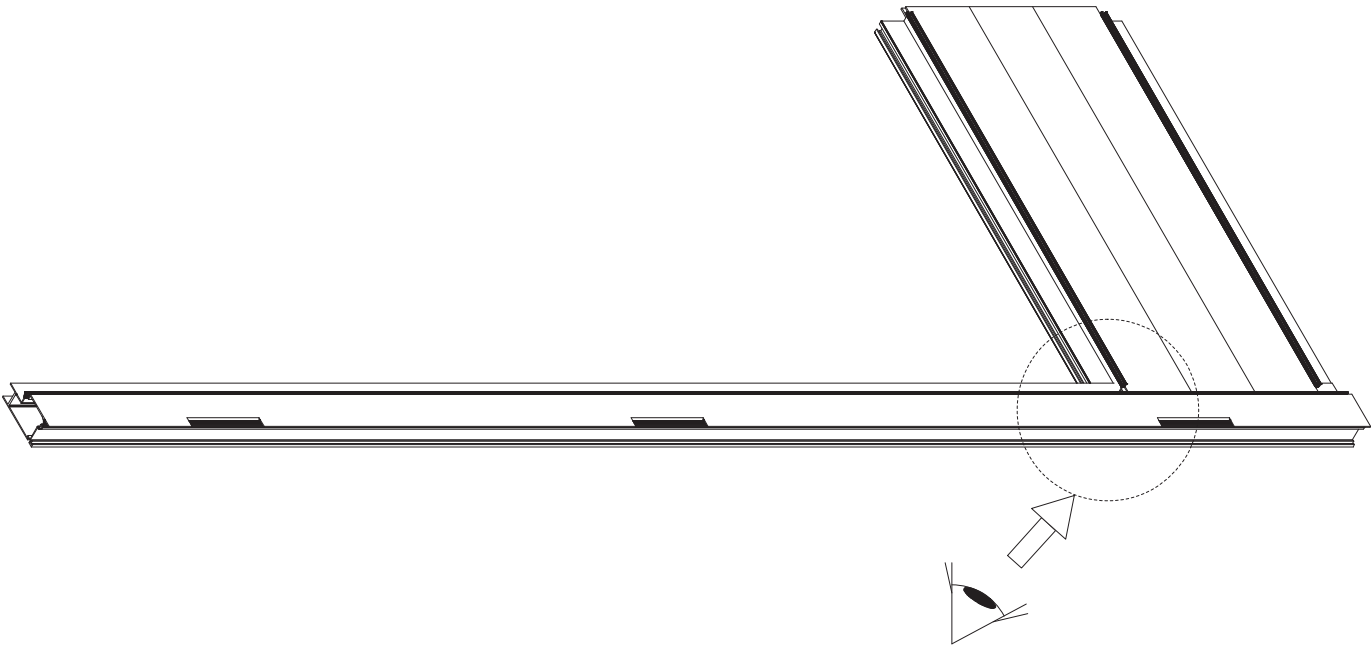

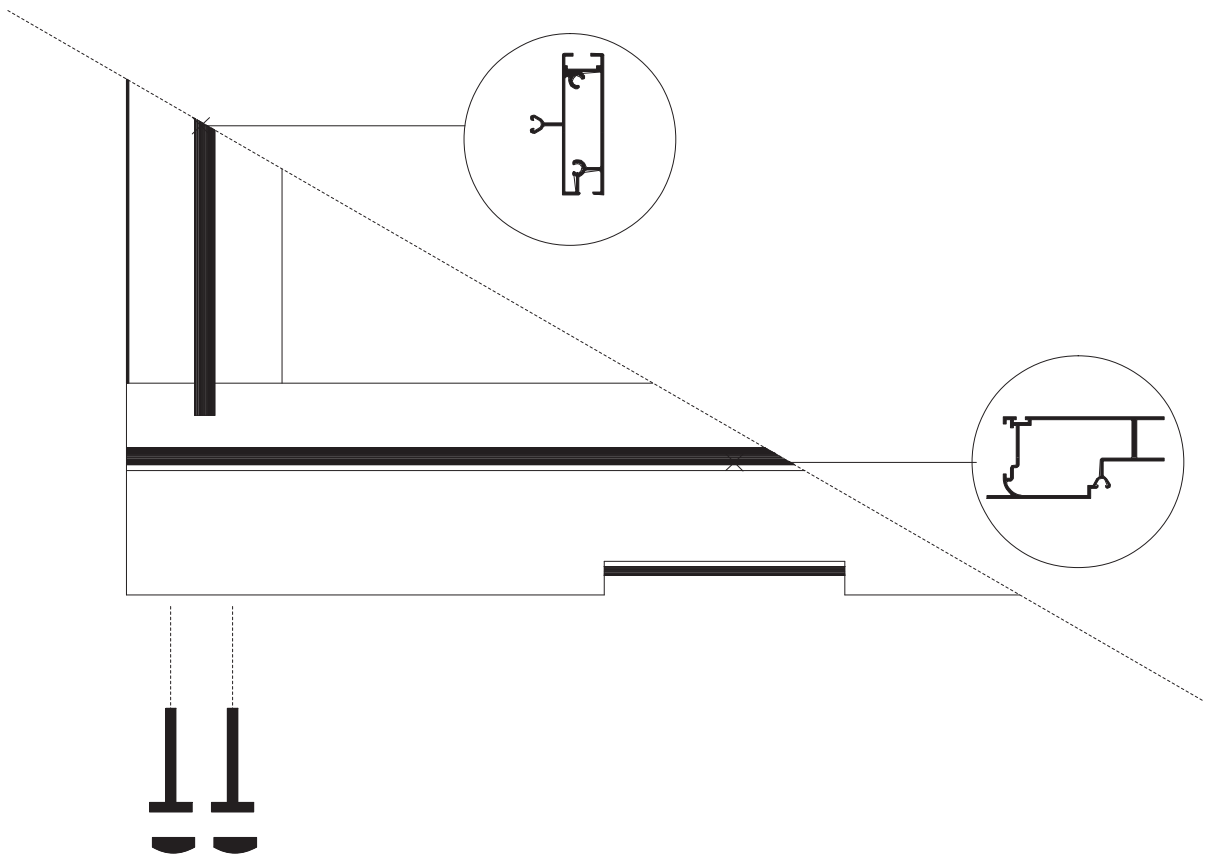
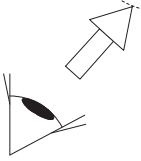

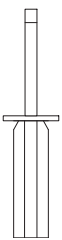
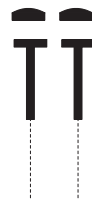
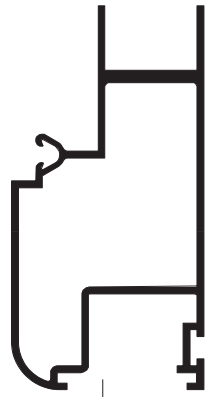

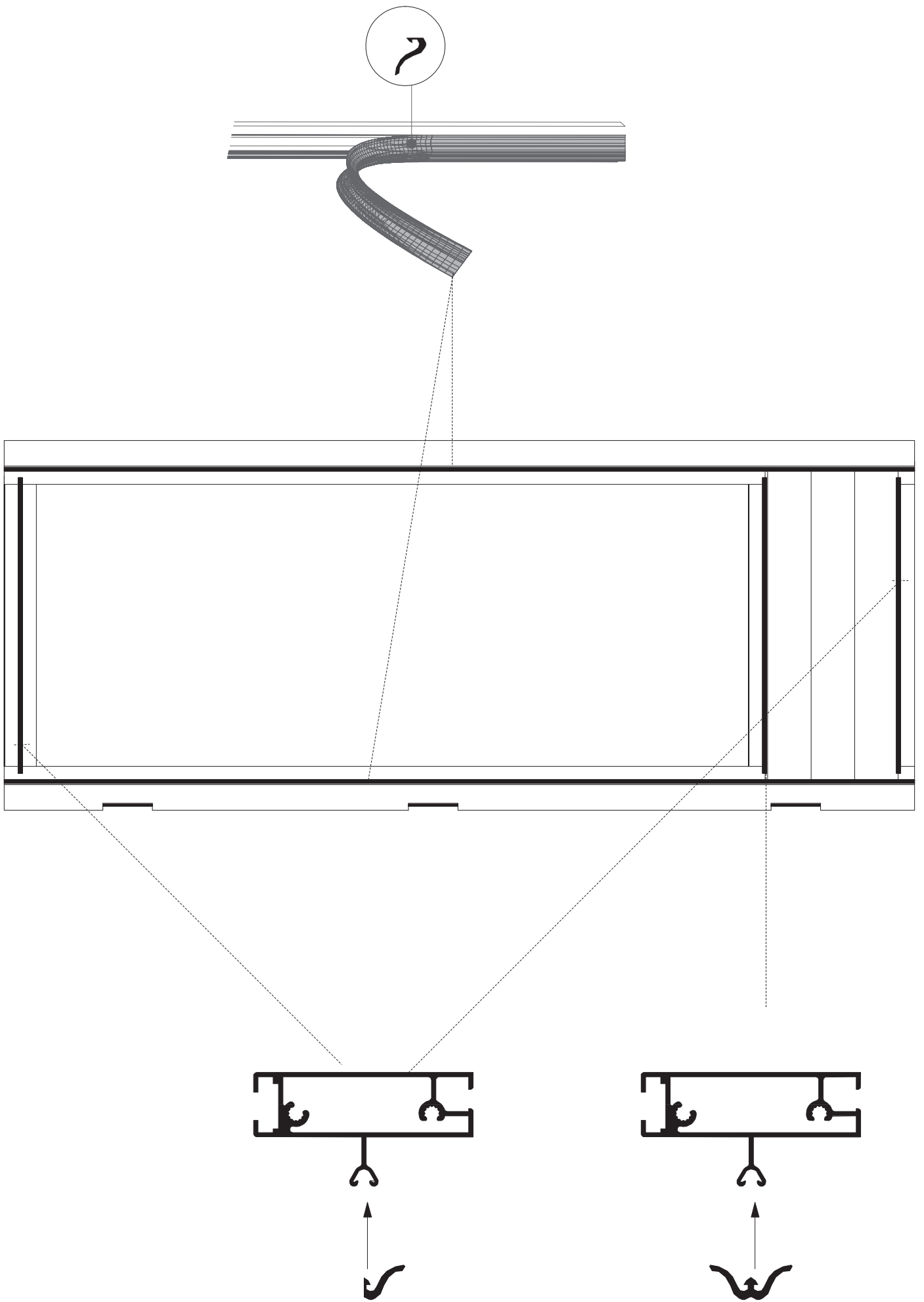

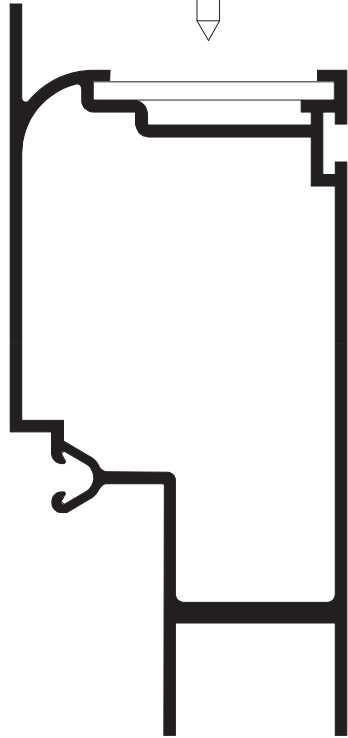
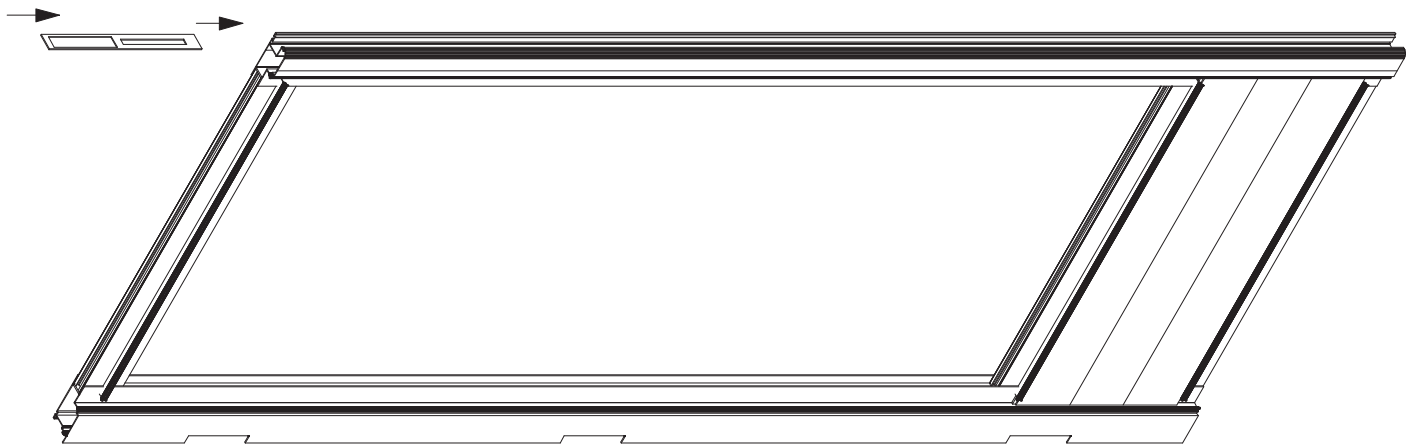

2 x

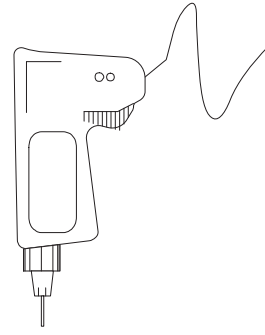

ø 3,5 mm

